

B620

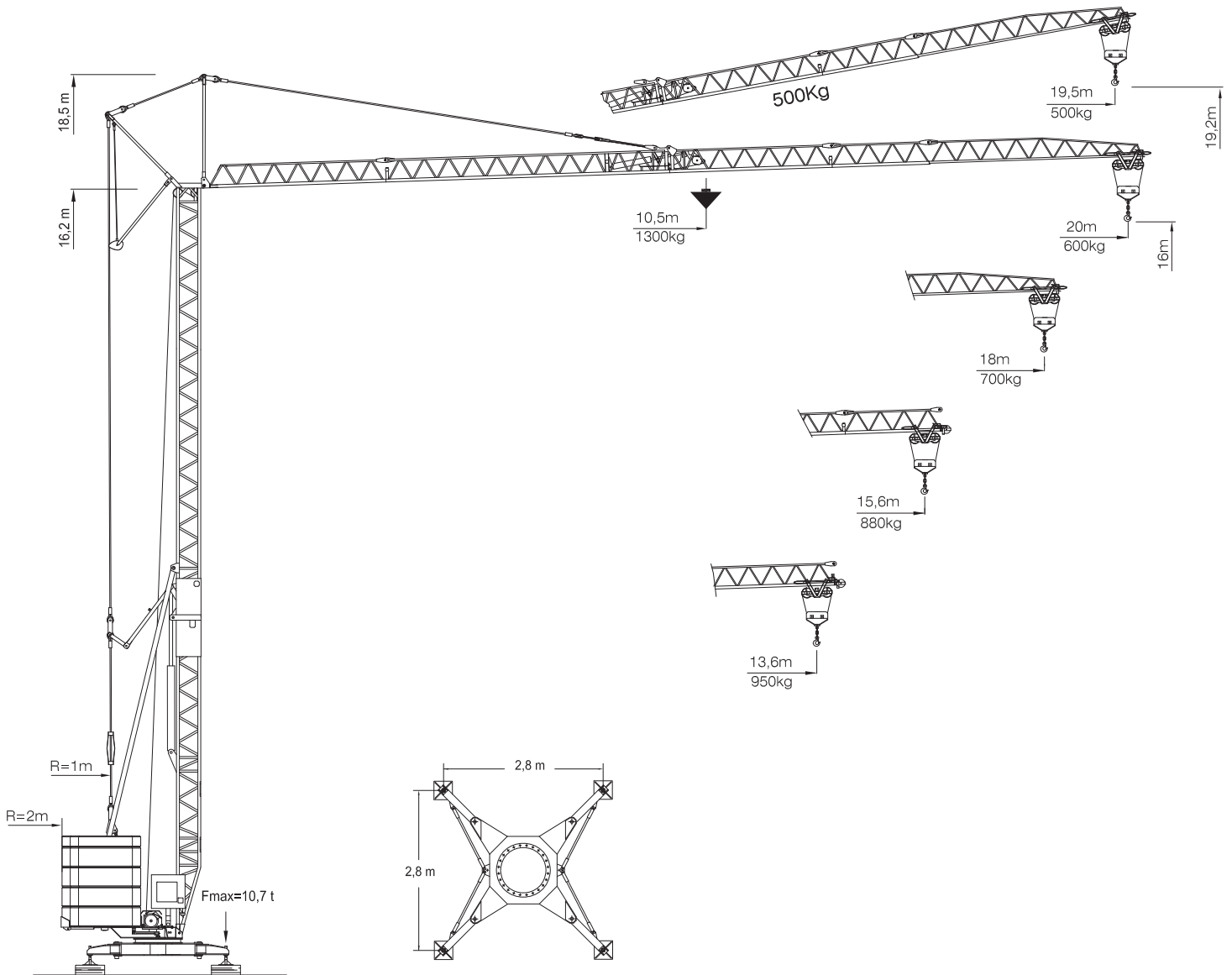

- Gru automontante
- Self erecting cranes
- Grúa automontante
- Grue auto montante



CE FEM A4

			400v/50hz 6kW		230v/50hz 3kW			
			m/min	kg	m/min	kg	kW	
Sollevamento Hoisting Levage Elevaciòn			4	1300kg	4	1300kg	3,0	
			13		13			
			30	600kg	22	600kg		
Traslazione Trolleying Distribution Distribuciòn			18	1300kg	18	1300kg	1,1	
			30	1300kg	30	1300kg		
			-	-	-	-		
Rotazione Slewing Orientation Orientaciòn			0,2 rpm	1300kg	0,2 rpm	1300kg	0,5	
			0,5 rpm		0,5 rpm			
			0,9 rpm		0,9 rpm			

Alimentazione Elettrica Main Supply Rèseau Alimentaciòn	230v/50hz - 3kW 400v/50hz - 6kW
Montaggio Erection Montage Montaje	230v/50hz - 2,2kW 400v/50hz - 2,2kW
Peso Gru Crane Weight Poids Grue Peso Grúa	5500 kg
Zavorra Ballast lest Lastre	9400 kg

B620

 Montaggio
  Erection
  Montaje
  Montage

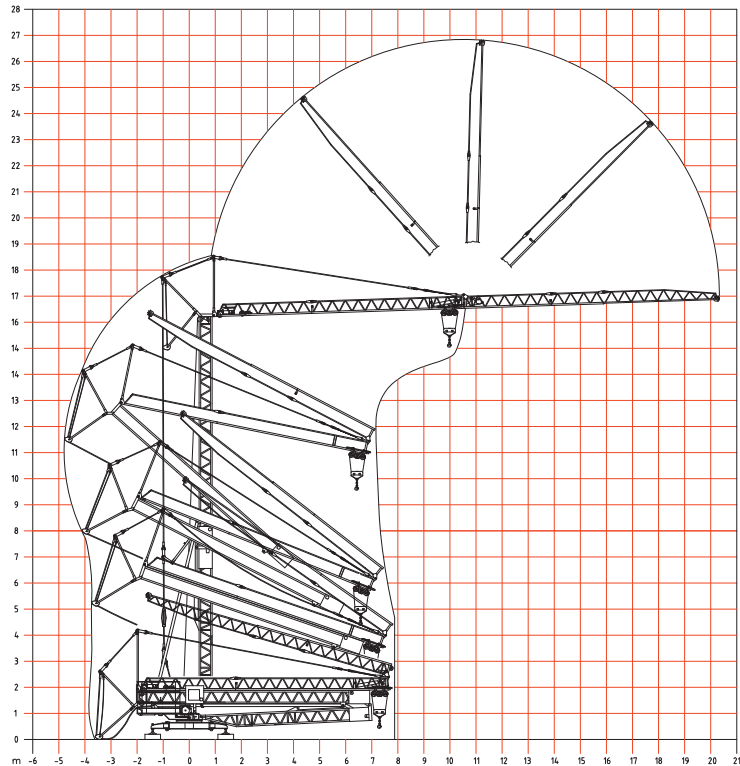

 Apertura aerea idraulica del braccio.
 Stabilizzatore idraulico per auto livellamento.
 Carro gommato con 8 ruote per traino.
 Sterzo montato su ralla.
 Una velocità carrello.
 Tre velocità di sollevamento con rampa di accelerazione e decelerazione pilotate da inverter.
 Due velocità di rotazione con rampa di accelerazione e decelerazione pilotate da inverter.
 Finecorsa di rotazione.
 Zincatura: torre, braccio, tiranti, cuspidi, funi, perni.
 Cofano apparecchiatura elettrica in acciaio inox
 Benna tronco conica.
 Impennaggio braccio con carrello traslante con portata costante kg.500.
 Funzionamento mono/trifase con adattamento automatico dei motori e delle apparecchiatura elettrica alla tensione di alimentazione: 220 volt monofase - 380 volt trifase.
 Radiocomando manipolatore.
 Radiocomando pulsantiera di emergenza.
 Sistema di tele-assistenza.



 Hydraulic air opening of the jib.
 Hydraulic stabiliser for self-levelling.
 Tyred truck with 8 wheels for towing.
 Steering wheel fitted on fifth wheel.
 One speed trolley.
 Three lifting speeds with acceleration and deceleration ramp controlled by inverter.
 Two rotation speeds with acceleration and deceleration ramp controlled by inverter.
 Rotation limit switch.
 Galvanising: tower, jibs, tie rods, struts, cables, pivots.
 Casing for electric equipment in stainless steel.
 Truncated cone bucket.
 Jib tail with traversing trolley with constant capacity 500 kg.
 Single/three phase operation.
 Automatic adaptation of the motors and the electrical equipment to the power voltage: 220 v single phase - 380 v three phase.
 Wireless joysticks keyboard.
 Wireless push-button emergency keyboard.
 Tele-assistance system.

 Despliegue hidráulico aéreo de la pluma.
 Estabilizador hidráulico para autonivelación.
 Chasis de 8 ruedas para remolque.
 Dirección montada sobre corona de giro.
 Una velocidad del carrito controladas por inverter.
 Tres velocidades de elevación con rampa de aceleración y desaceleración controladas por inverter.
 Dos velocidades de giro con rampa de aceleración y desaceleración controladas por inverter.
 Limitadores de giro.
 Cincado: torre, plumas, tirantes, cúspides, cables, pernos.
 Armario equipo eléctrico en acero inoxidable.
 Cubilote.
 Izado pluma con carro de traslación de carga constante en modo trifásico de 500 kg.
 Funcionamiento monofásico con ajuste automático de los motores y del equipo eléctrico a la tensión de alimentación: 220 volt monofásica - 380 volt trifásica.
 Radiocomando con manipulador.
 Radiocomando con botones de emergencia.
 Sistema de tele-asistencia.

 Dépliage hydraulique aérien de la flèche.
 Vérin de stabilité hydraulique pour auto-nivelage.
 Châssis mobile à 8 roues pour remorque.
 Système d'orientation monté sur sellette d'attelage.
 Une vitesse du chariot commandées par inverter.
 Trois vitesses de levage avec rampe d'accélération et de décélération commandées par inverter.
 Deux vitesses de rotation avec rampe d'accélération et de décélération commandées par inverter.
 Butée de rotation.
 Zingage : tour, flèches, tirants, têtes, câbles, pivots.
 Capot en acier inoxydable pour appareillage électrique.
 Banne en béton.
 Empennage de la flèche avec chariot translateur à capacité constante en triphasé de 500 kg.
 Fonctionnement en mono-triphasé avec régulation automatique des moteurs et de l'appareillage électrique à la tension d'alimentation: 220 v monophasé - 380 v triphasé.
 Télécommande radio à manipulateur.
 Télécommande avec boutons de urgence.
 Système de télé-assistance.

I dati tecnici possono essere soggetti a modifiche.  The technical data can be subject to change.  Les données techniques peuvent être sujets à changement.  Los datos técnicos pueden estar sujetos a cambios.

 Trasporto
 Transportation
 Transporte
 Transport

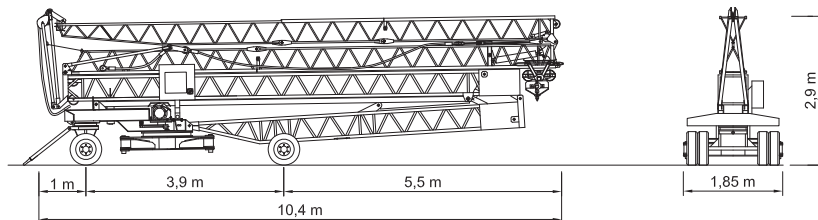



Via Circonvallazione Est, 29
 46047 Porto Mantovano MN - ITALY
 Tel. +39 0376 389611
 Fax +39 0376 389630
 www.grubenedini.it
 info@grubenedini.it

Rivenditore / Reseller / Minorista / Détaillant